



**MODEL:** WST-1203UX  
**PRODUCT:** Electromagnetic Buzzer  
**EDITION:** A/2016

**THIS SPECIFICATION APPLIES TO THE ELECTROMAGNETIC BUZZER**

**SPECIFICATION**

Test condition: TEMP=+25±2 °C Related humidity=65±5% Air pressure: 860 ~ 1060mbar

item	unit	specification	condition
rated voltage	Vo-p	3.0	
operating volt	Vo-p	2.0 ~ 4.0	
mean current	mA	Max.30	At rated voltage direct current
coil resistance	Ω		
sound output	dBA	82	At 10cm(A-weight free air), and at rated voltage direct current
rated frequency	Hz	2300 ± 400	
operating temp	°C	-20 ~ +60	
storage temp	°C	-30 ~ +70	
dimension	mm	φ12.0×H7.5	See attached drawing
weight	gram	2.0	
material		PPO (Black)	
terminal		Pin type	See attached drawing
environmental protection regulation		RoHS	

**ENVIRONMENT TEST**

item	test condition	evaluation standard
high temp. test	After being placed in a chamber at +70°C for 96 hours.	After the test the part will meet specifications without any degradation in appearance and performance except SPL, after 4 hours at +25°C. The SPL will be in ±10dBA compared with initial one.
low temp. test	After being placed in a chamber at -30°C for 96 hours.	
thermal shock	The part will be subjected to 10 cycles. One cycle shall consist of:	

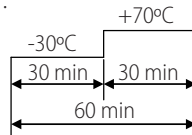

temp./humidity cycle	The part will be subjected to 10 cycles. One cycle shall be 24 hours and consist of:
----------------------	---

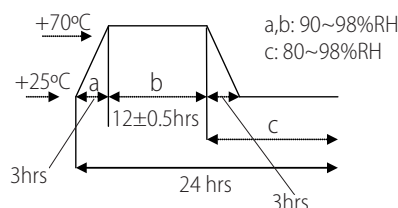



**MODEL:** WST-1203UX  
**PRODUCT:** Electromagnetic Buzzer  
**EDITION:** A/2016

## RELIABILITY TEST

item	test conditions	evaluation standard
operating life test	ORDINARY TEMPERATURE The part will be subjected to 96 hours of continuous operation at room temperature.	After the test the part will meet specifications without any degradation in appearance and performance except SPL, after 4 hours at +25°C. The SPL would be in $\pm 10$ dBA compared with initial one.
	HIGH TEMPERATURE The part will be subjected to 72 hours of continuous operation at +60°C with 3.0V applied.	
	LOW TEMPERATURE The part will be subjected to 72 hours of continuous operation at -20°C with 3.0V applied.	
	HIGH AND LOW VOLTAGE Applying 2.0 voltage and 4.0 voltage, available time 24 hours each.	

### TEST CONDITION

Standard Test Condition: a)Temperature: +5~+35°C b)Humidity:45~85% c)Pressure: 860~1060mbar

## MECHANICAL CHARACTERISTICS

item	test conditions	evaluation standard
solderability	Lead terminal are immersed in rosin for 5 seconds and then immersed in solder bath of +250 $\pm$ 5°C for 3 $\pm$ 0.5 seconds.	90% min. lead terminals will be wet with solder No interference in operation.
soldering heat resistance	Lead terminal are immersed in soldering bath of +250 $\pm$ 5°C for 2 $\pm$ 0.5 seconds.	No interference in operation
terminal mechanical strength	Apply the terminal with 1KG tension for 1 minute	No damage and cutting off.
vibration	The part will be subjected to a vibration cycle of 10Hz to 55Hz to 10Hz in a period of 1 minute. Total peak amplitude will be 1.52mm(9.3G). The vibration test will consist of 2 hours per axis in each three axes(X,Y,Z). Total 6 hours.	After the test the part will meet specifications without any damage in appearance and performance except SPL. The SPL would be 80dBA compared with initial one.
drop test	The part only will be dropped from a height of 75cm onto a 40mm thick wooden board 3 times in 3 axes (X, Y, Z). Total of 9 times.	

## RECOMMENDED WAVE SOLDERING TEMPERATURE CURVE

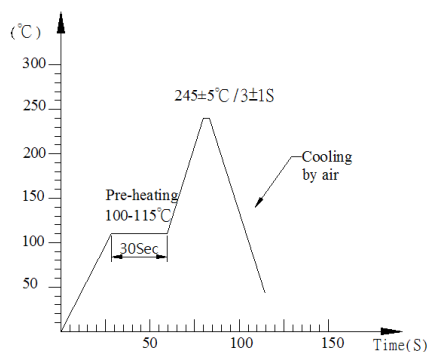



**MODEL:** WST-1203UX  
**PRODUCT:** Electromagnetic Buzzer  
**EDITION:** A/2016

### INSPECTION FIXTURE

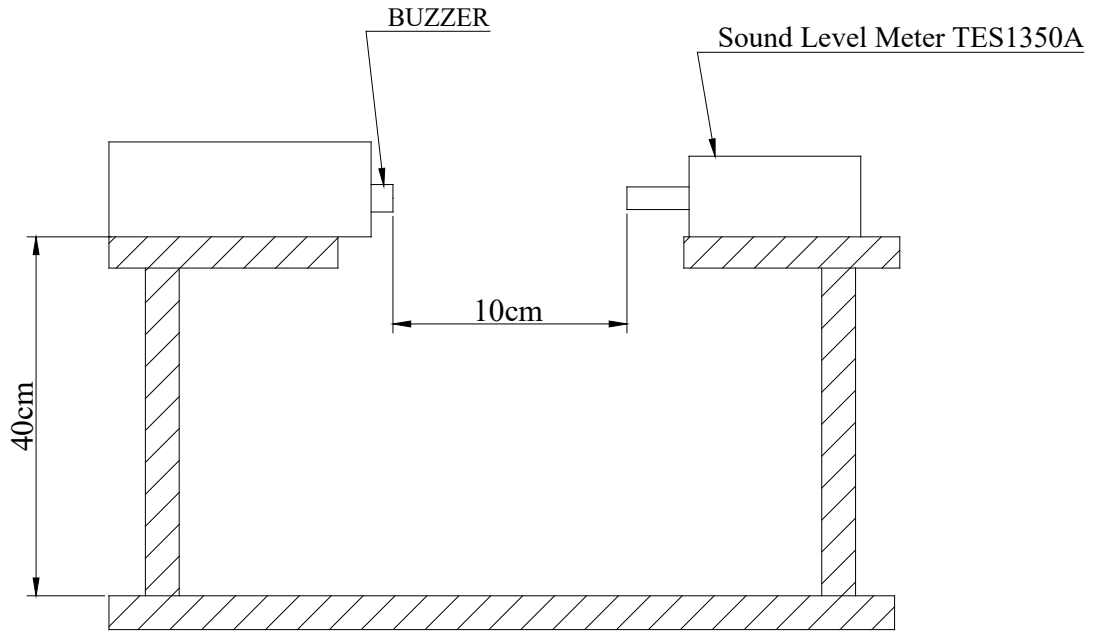

### FREQUENCY RESPONSE

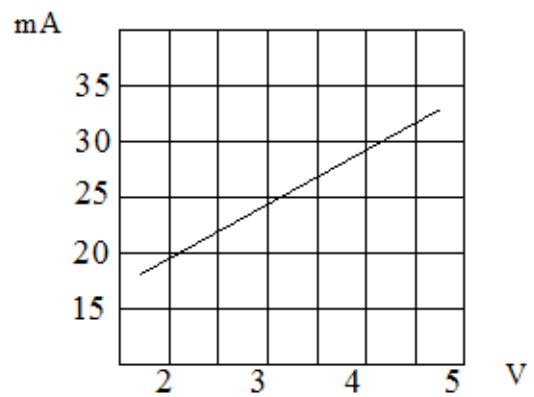
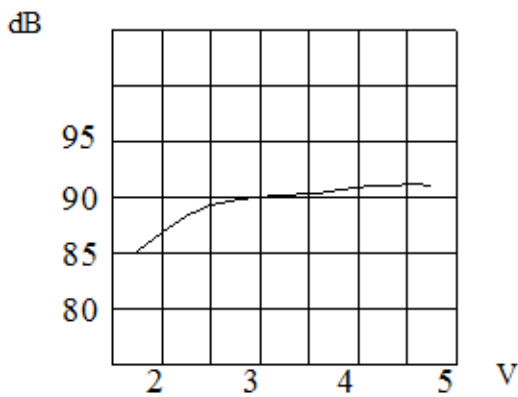



**MODEL:** WST-1203UX  
**PRODUCT:** Electromagnetic Buzzer  
**EDITION:** A/2016

**DIMENSIONS**

Tolerance: ±0.5 (unit: mm)

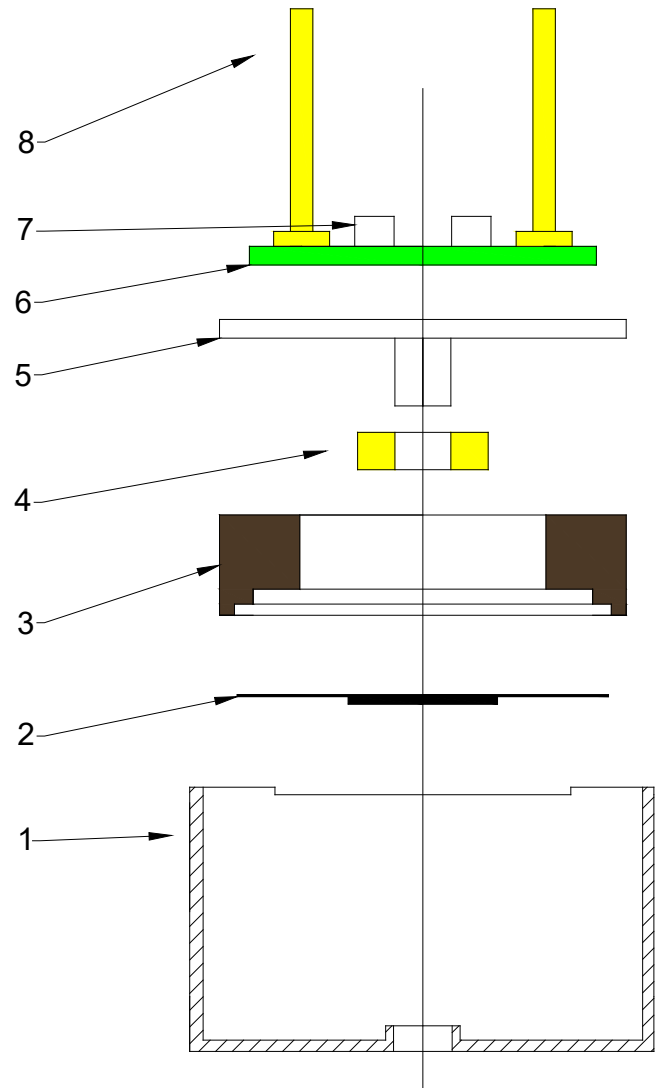
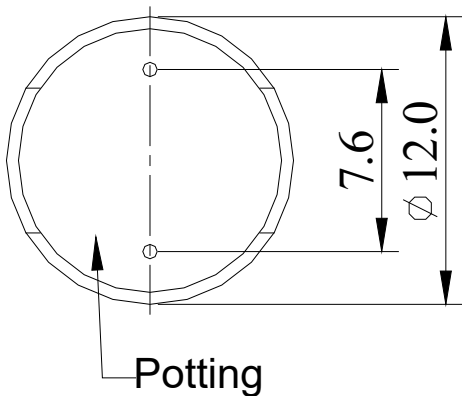
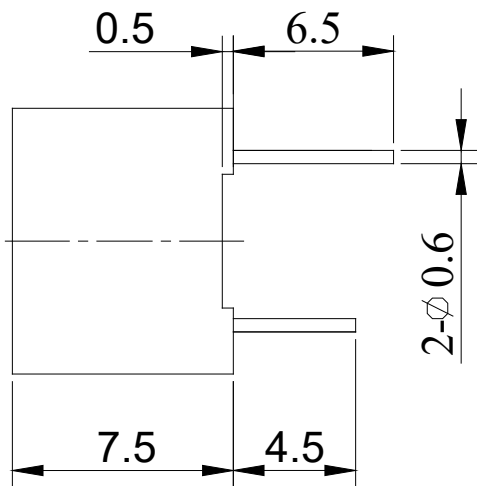
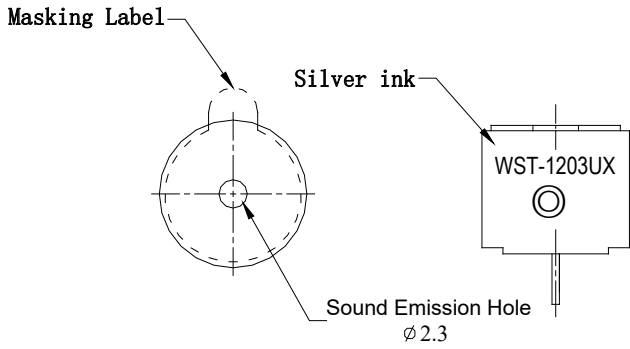

no	item	material	quantity
1	CASE	PPO	1
2	Diaphragm	Ferrum	1
3	Magnet ring	Poly+ferrite	1
4	Coil	Copper	1
5	Core	Ferrum	1
6	PCB	Epoxy glass fiber cloth + copper	1
7	Transistor	Epoxy + copper	2
8	PIN	Copper	2



**MODEL:** WST-1203UX  
**PRODUCT:** Electromagnetic Buzzer  
**EDITION:** A/2016

Soberton Inc.

## PACKING

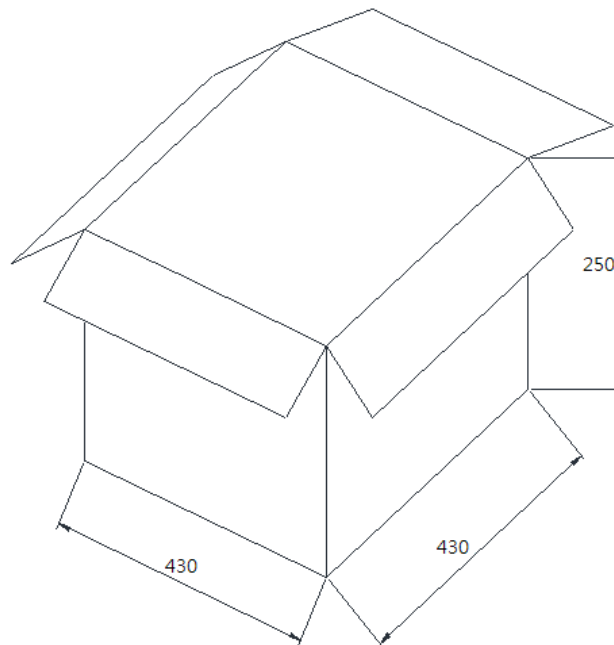
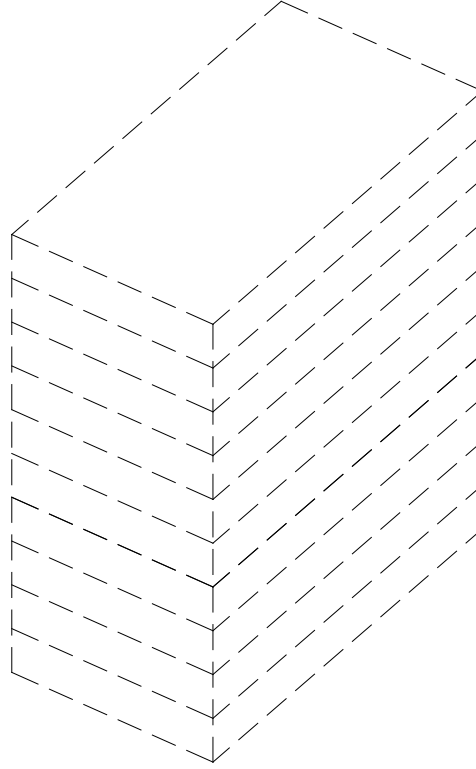

packing box	LxWxH (mm)	pieces
Tray	190x190x25	100
Inner cartons	210x210x220	1000
Outer cartons	430x430x250	4000