

Photoelectrics

Laser, Diffuse-reflective, Background Suppression

Type LD32CNB06

CARLO GAVAZZI



- Miniature sensor range
- Range: 60 mm
- Sensitivity adjustment by Teach-In programming
- Modulated, red laser light, 650 nm (class 2)
- Supply voltage: 10 to 30 VDC
- Output: 100 mA, NPN or PNP preset
- Make and break switching function programmable
- LED for output indication, signal stability and power ON
- Protection: reverse polarity, short circuit and transients
- Cable and plug versions
- Compact housing
- Excellent EMC performance



Product Description

The LD32 sensor family is available in a compact 12 x 32 x 20 mm reinforced PMMA/ABS-housing. The sensors are useful in applications where high-accuracy detection as well as small size is required. The Teach-In function for adjustment of the sensitivity makes the sensors highly

flexible. The small spot and background suppression makes the sensor able to detect small objects close to the background. The output type is preset (NPN or PNP), and the output switching function is programmable (NO or NC).

Ordering Key

LD32CNB06PPM5T

Type	_____
Housing style	_____
Housing size	_____
Housing material	_____
Housing length	_____
Detection principle	_____
Sensing distance	_____
Output type	_____
Output configuration	_____
Connection type	_____
Teach-In	_____

Type Selection

Housing W x H x D	Range S _n	Ordering no. NPN & PNP cable Make & break switching	Ordering no. NPN & PNP plug Make & break switching
12 x 32 x 20 mm	60 mm	LD 32 CNB 06 NPT LD 32 CNB 06 PPT	LD 32 CNB 06 NPM5T LD 32 CNB 06 PPM5T

Specifications

Rated operating distance (S_n)	Up to 60 mm, reference target Kodak test card R 27, white, 90% reflectivity, 100 x 100 mm	Minimum operational current (I_m)	0.5 mA
Blind zone	≤ 25 mm	OFF-state current (I_r)	≤ 100 μA
Sensitivity	Adjustable by Teach-In (push button or wire)	Voltage drop (U_d)	≤ 2.4 VDC @ 100 mA
Temperature drift	≤ 1%/°C	Protection	Short-circuit, reverse polarity and transients
Hysteresis (H) (differential travel)	≤ 7% (grey scale displacement 90%/18%)	Laser protection class	Class 2 - according to EN60825-1-3/97
Rated operational volt. (U_B)	10 to 30 VDC (ripple included)	Average power	< 1 mW
Ripple (U_{ripp})	≤ 10%	Pulse width	t = 3 μs
Output current Continuous (I _a) Short-time (I)	≤ 100 mA ≤ 100 mA (max. load capacity 100 nF)	Pulse repetition time	f = 5 kHz
No load supply current (I₀)	≤ 25 mA @ 24 VDC	MTBF	> 50'000 h @ T _a = 40°C
		Light source	Laser red light, 650 nm
		Light type	Red, modulated
		Sensing angle	< 0.8°
		Ambient light	5,000 lux
		Light spot	< 0.5 mm
		Operating frequency	1000 Hz
		Response time OFF-ON (t _{ON}) ON-OFF (t _{OFF})	≤ 0.5 ms ≤ 0.5 ms
		Power ON delay (t_v)	≤ 300 ms

Specifications (cont.)

Output function NPN and PNP NO/NC switching function	Preset Set up by button	Vibration	10 to 55 Hz, 0.5 mm/7.5 g (IEC 60068-2-6)
External Teach (ET) Same function as button Locked (disable teach button) Operating mode	10 to 30 VDC 0 to 2.5 VDC Not connected	Shock	30 g / 11 ms, 3 pos, 3 neg per axis (IEC 60068-2-6, 60068-2-32)
Indication Output ON Power ON	LED, yellow LED, green	Rated insulation voltage	500 VAC (rms)
Environment Installation category	II (IEC 60664/60664A; 60947-1)	Housing material Body Front material	ABS, black PMMA, red
Pollution degree	3 (IEC 60664/60664A; 60947-1)	Connection Cable	PUR, black, 2 m 4 x 0.14 mm ² , Ø = 3.6 mm
Degree of protection	IP 67 (IEC 60529; 60947-1)	Plug	M8, 4-pin
Ambient temperature Operating Storage	-20° to +60°C (-4° to +140°F) -20° to +80°C (-4° to +176°F)	Weight	Cable type: 40 g Plug type: 10 g
		CE-marking	Yes

Operation Diagram

tv = Power ON delay

Power supply

Object/target present

Break (NC) Output ON

Make (NO) Output ON

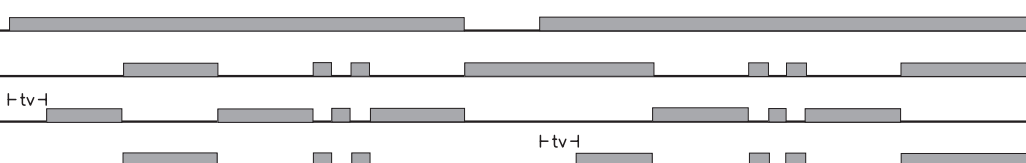

Wiring Diagrams

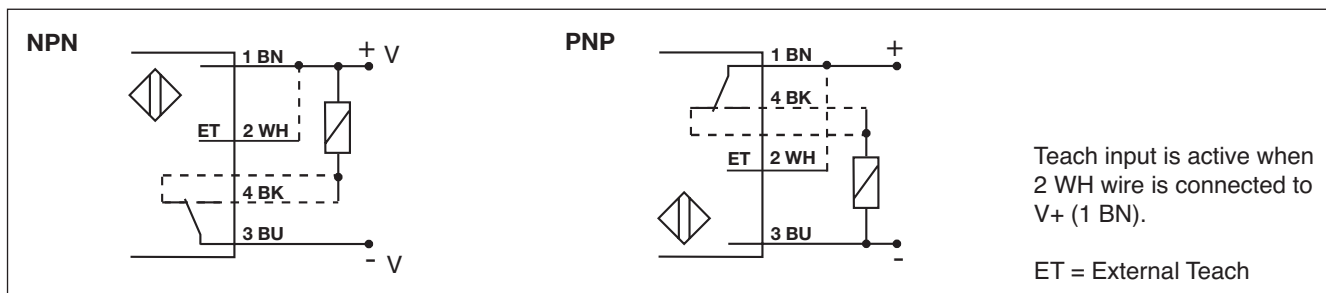

Installation Hints

To avoid interference from inductive voltage/current peaks, separate the prox. switch power cables from any other power cables, e.g. motor, contactor or solenoid cables

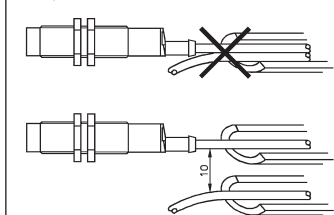

Relief of cable strain

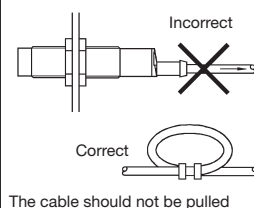

The cable should not be pulled

Protection of the sensing face

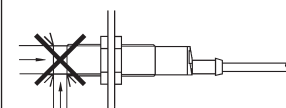

A proximity switch should not serve as mechanical stop

Switch mounted on mobile carrier

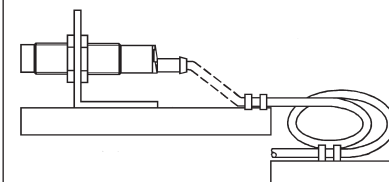

Any repetitive flexing of the cable should be avoided

Dimensions

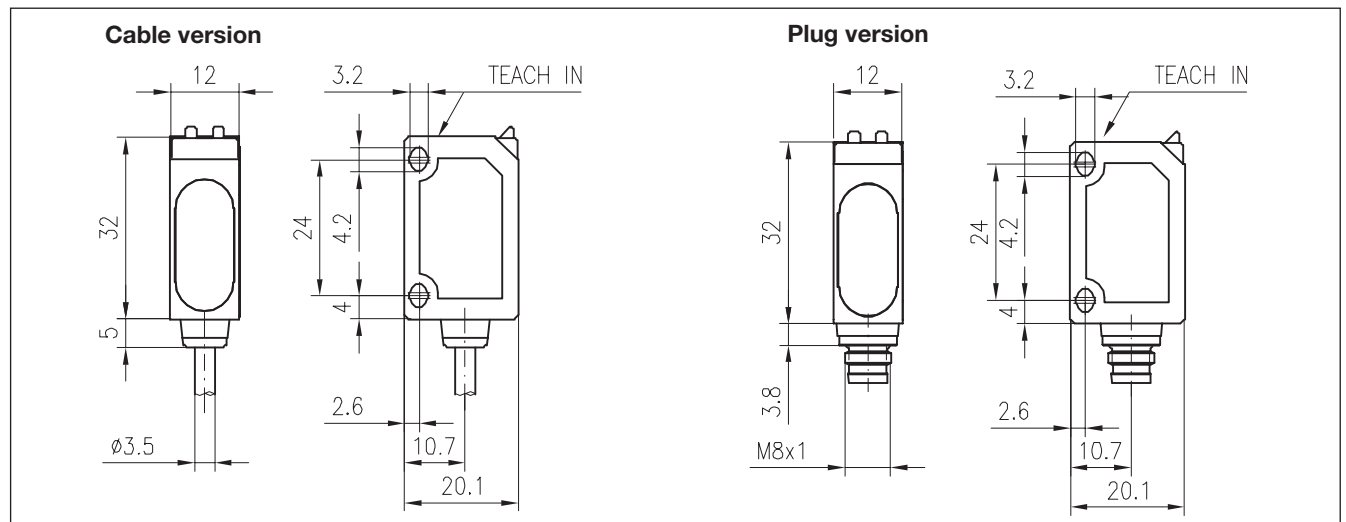

Accessories

Mounting bracket APD32-MB3

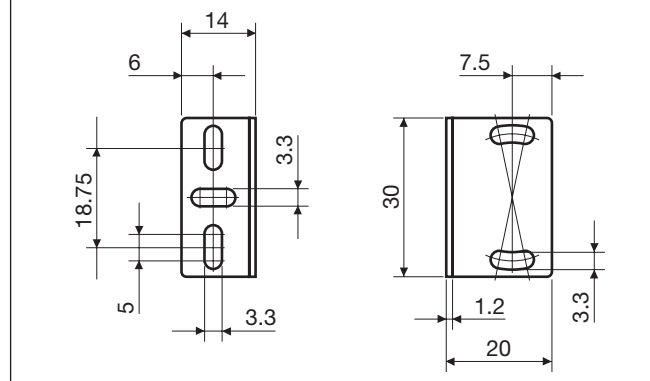

For further information refer to "Accessories"

Delivery Contents

- Photoelectric switch: LD 32 CNB 06 ...
- Installation instruction
- **Packaging:** Cardboard box

Adjustment

Sensitivity adjustment, with static object

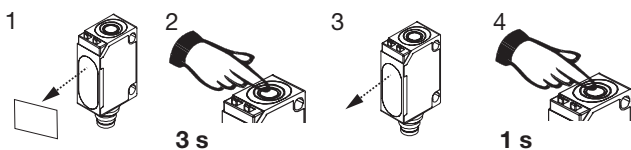

1. Line up the sensor with the object. Yellow LED and green LED are ON.
2. Press the button for 3 s until both LED's flash simultaneously (the first switching point is stored).
3. Place the object outside the detection area.
4. Press the button for 1 s.
 - a) The green LED flashes and stays ON: the second switching point is stored, and the sensor is ready to operate.
 - b) Both LED's flash simultaneously: the sensor cannot detect the object, no switching points are stored.



Sensitivity adjustment, with only one object

1. Line up the sensor with the object. Yellow LED and green LED are ON.
2. Press the button for 3 s until both LED's flash simultaneously (the first switching point is stored).
3. Leave the object in the detection area, press the button for 1 s. The green LED flashes and stays on: the second switching point is stored, and the sensor is ready to operate.



Sensitivity adjustment, with a running process

1. Line up the sensor with the object. Green LED is ON. At this stage the status of the yellow LED can be ignored.
2. The running process must be the only "object" within the detection area. Press the button for 3 s until both LED's flash simultaneously.
  **3 s**
3. Press the button for at least the duration of one process cycle.
  **1 cycle**
 - a) The green LED flashes and stays ON: both switching points have been stored, and the sensor is ready to operate.
 - b) Both LED's flash simultaneously: the sensor cannot detect the object, no switching points are stored.

Programming of make and break switching function

1. Press the button for 13 s.  **13 s**
Both LED's flash alternately.
2. Release the button: the green LED flashes.
3. While the green LED flashes, the output is inverted each time the button is pressed. This is indicated by the yellow LED.
When the button is not pressed for 10 s, the current output function is stored.
The sensor is now ready for operation.

Default setting

1. No object in the detection area: Press the button for 3 s, until both LED's flash simultaneously.  **3 s**
2. No object in the detection area:
Press the button for 1 s.  **1 s**
The sensor is set to maximum sensitivity.

NB! The Teach Input (2 WH) will work similarly to the push button, active High.